



CFA Society of Madison & Milwaukee

November 13, 2012



VEHICLE ACCESS SYSTEMS TECHNOLOGY



WITTE • STRATTEC • ADAC

Patrick J. Hansen

Senior Vice President & CFO



VEHICLE ACCESS SYSTEMS TECHNOLOGY



WITTE • STRATTEC • ADAC

Disclosure for Presentation at Baird Industrial Conference

This presentation contains “forward-looking statements” within the meaning of the Private Securities Litigation Reform Act of 1995. These statements may include expected future financial results, product offerings, global expansion, liquidity needs, financing ability, planned capital expenditures, management’s or the Company’s expectations and beliefs, and similar matters. The Company’s business, operations and financial performance are subject to certain risks and uncertainties, which could result in material differences in actual results from the Company’s current expectations. These risks and uncertainties include, but are not limited to, general economic conditions, in particular, relating to the automotive industry, customer demand for the Company’s and its customer’s products, competitive and technological developments, customer purchasing actions, foreign currency fluctuations and costs of operations. Such risks and uncertainties are discussed further in the Company’s filings with the Securities and Exchange Commission.

This presentation includes selected information regarding the Company’s business, operations and financial performance and is qualified in its entirety by the more complete information contained in the Company’s filings with the Securities and Exchange Commission and other public disclosures.

All information in this presentation is as of November 13, 2012 and any distribution of this presentation after that date is not intended and will not be construed as updating or confirming such information. The company undertakes no obligation to update any information in this presentation to reflect subsequent events or circumstances.

This presentation can be found at:
www.strattec.com
Investor Relations
Presentations



Company History



- 1908 Briggs & Stratton Corporation formed
- February 27, 1995 Briggs & Stratton spins off their lock division as a separate publicly traded company named "STRATTEC SECURITY CORPORATION" (Symbol STRT traded on NASDAQ)
- November 28, 2000 Alliance and joint venture formed between STRATTEC and WITTE creating WITTE-STRATTEC LLC
- November, 2001 Joint venture is formed with Brazilian partner and WITTE-STRATTEC LLC to create WITTE-STRATTEC do Brasil
- March 1, 2002 Joint venture is formed with Taiwanese Company to form WITTE-STRATTEC China



VEHICLE ACCESS SYSTEMS TECHNOLOGY



WITTE • STRATTEC • ADAC

Company History (continued)



- March, 2004 Second facility and legal entity is formed in Shanghai called WITTE-STRATTEC Great Shanghai
- July 1, 2006 ADAC Plastics Inc. – Grand Rapids, MI joins WITTE-STRATTEC LLC joint venture which is renamed Vehicle Access Systems Technology (VAST LLC). Other outside joint ventures are renamed VAST China and VAST do Brasil
- October, 2006 STRATTEC and ADAC create joint venture ADAC-STRATTEC de Mexico to produce door handle components in Juarez, Mexico
- August, 2007 VAST establishes sales office in Japan (VAST Japan)
- November 30, 2008 STRATTEC, WITTE and VAST acquire the global Delphi Power Products business. STRATTEC creates joint venture with WITTE called STRATTEC Power Access LLC for power sliding doors and lift gates. Sales & Engineering office is also created in Seoul Korea called VAST Korea to service primarily Hyundai/Kia and other OEM's.



VEHICLE ACCESS SYSTEMS TECHNOLOGY



WITTE • STRATTEC • ADAC

Milwaukee, WI - 340 Employees

Headquarters, Engineering, Parts Manufacturing

Juarez, Mexico - 2,150 Employees

2 Facilities – Assembly & Plastic Injection Molding

El Paso, Texas - 20 Employees

Distribution

Troy, Michigan - 60 Employees

Sales and Engineering

Financial Information

1st Quarter, FY '13 Results

(000's except per share amounts)



	September <u>2012</u>	September <u>2011</u>
Net Sales	\$ 70,807	\$ 66,377
Gross Profit	\$ 13,713 19.4%	\$ 11,504 17.3%
Operating Expenses	\$ 9,120 12.9%	\$ 8,208 12.4%
Net Income	\$ 2,670	\$ 1,282
Diluted Earnings Per Share	\$.78	\$.39



VEHICLE ACCESS SYSTEMS TECHNOLOGY



- Year over Year improvement in gross margins:
 - Reduction in scrap costs
 - Reduction in transportation costs
 - Favorable product sales mix
 - Favorable Mexican Peso to US dollar exchange rate

- Increase in Operating Expenses
 - Higher costs for pensions, bonuses, medical and product development

Outlook Going Forward



- Based on current customer orders we anticipate approximately \$68 million in sales in our second quarter compared to \$65.9 million in the prior year quarter.
- Capital spending will be in the \$9 - 10 million range during fiscal year 2013.
- STRATTEC Defined Benefit Pension Plan was frozen effective December 31, 2009. Anticipate Plan contributions in fiscal 2013 of \$3.0 million compared to \$2.0 million in fiscal 2012

	<u>FY 2012</u>	<u>FY 2011</u>
Plan Benefit Obligation	\$103.4	\$89.6
Plan Assets	<u>\$79.5</u>	<u>\$83.0</u>
Under Funded Status	\$23.9	\$6.6

- As of September 30, 2012, the Company had in excess of \$16 million of cash or \$5/share and anticipated funding the above requirements primarily from current operating cash flows.
- We have \$30 million of credit facilities available with BMO Harris Bank with current borrowings outstanding of \$1.5 million.



Product and Sales Information

2001

Keys & Locksets

- Mechanical keys
- Mechanical keys w/ electronic security enhancements
- Ignition locks
- Door locks
- Rear compartment locks
- Glove box locks
- Accessory locks

Driver Controls

- Steering column mounted ignition lock housings

Miscellaneous Industrial

- Zinc die-castings

2012

All the products in place in 2001, plus

Keys & Locksets

- Electro-mechanical entry keys w/remote entry electronics
- Bladeless electronic keys
- Electronic remote entry key fobs
- Codeable locks

Driver Controls

- Instrument panel mounted ignition lock housings
- Instrument panel docking receivers for bladeless electronic keys
- Instrument panel "Push to Start" ignition switches for passive security systems

Latches

- Rear compartment (tailgate, liftgate, trunk lid)
- Seat Back

Power Access

- Power sliding side door systems
- Power liftgate
- Power trunk lid
- Power cinching latches & strikers
- Electronic control modules

Door Handles & Functional Exterior Trim

- Inside and outside handles
- Outside handle chassis
- Rear license plate light bars with park assist cameras and/or concealed switches for releasing rear compartment latches

Miscellaneous Industrial

- **i-Guard** electronic vehicular access systems

Sales by Products

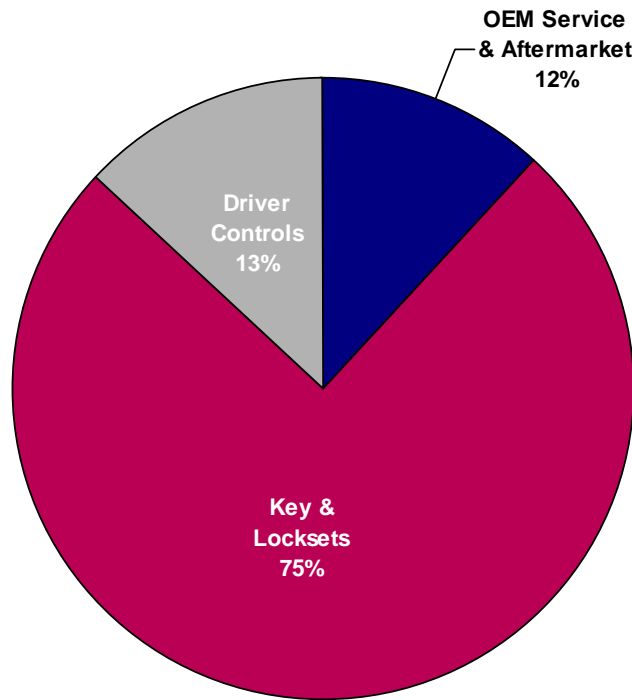

Fiscal Year 2001
Net Sales = \$203 million

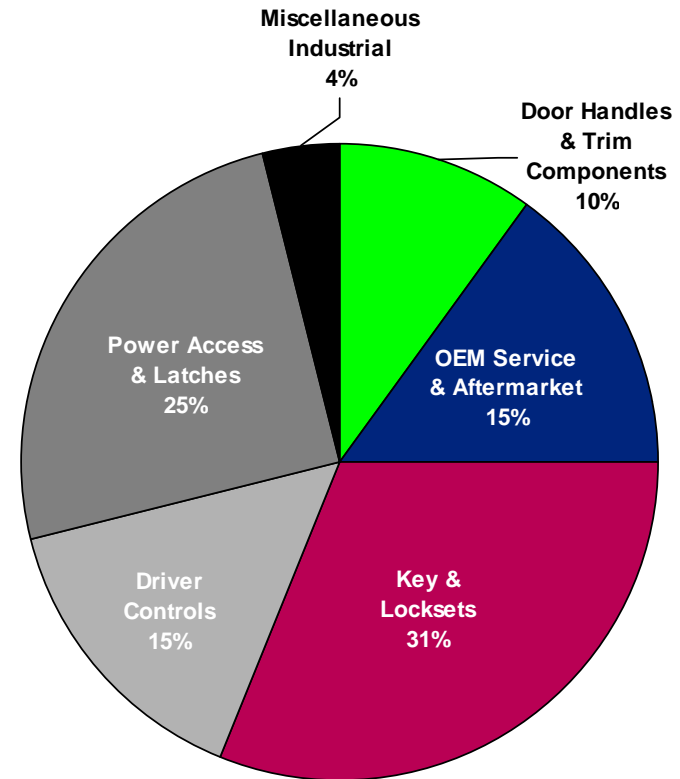

Fiscal Year 2011
Net Sales = \$261 million



VEHICLE ACCESS SYSTEMS TECHNOLOGY



WITTE • STRATTEC • ADAC

Sales by Customer

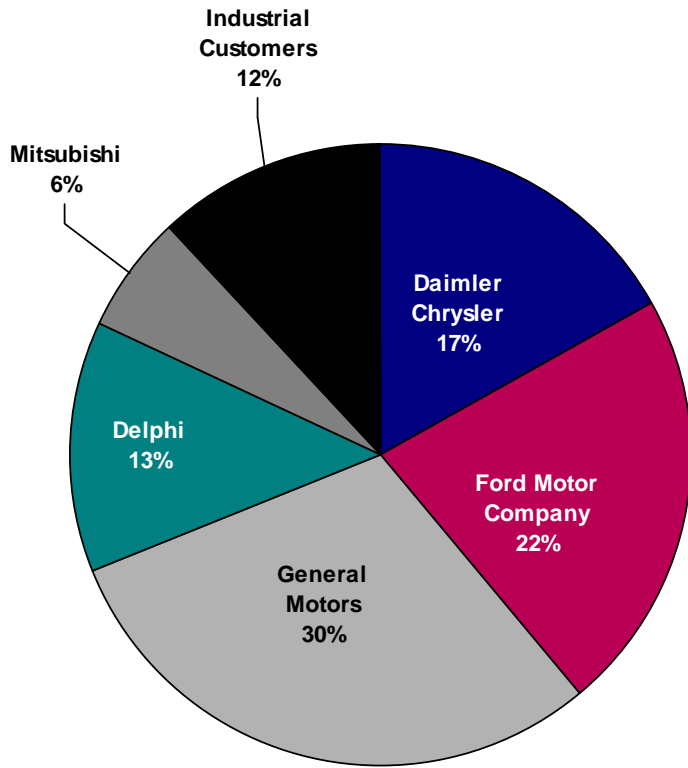

Fiscal Year 2001
Net Sales = \$203 million

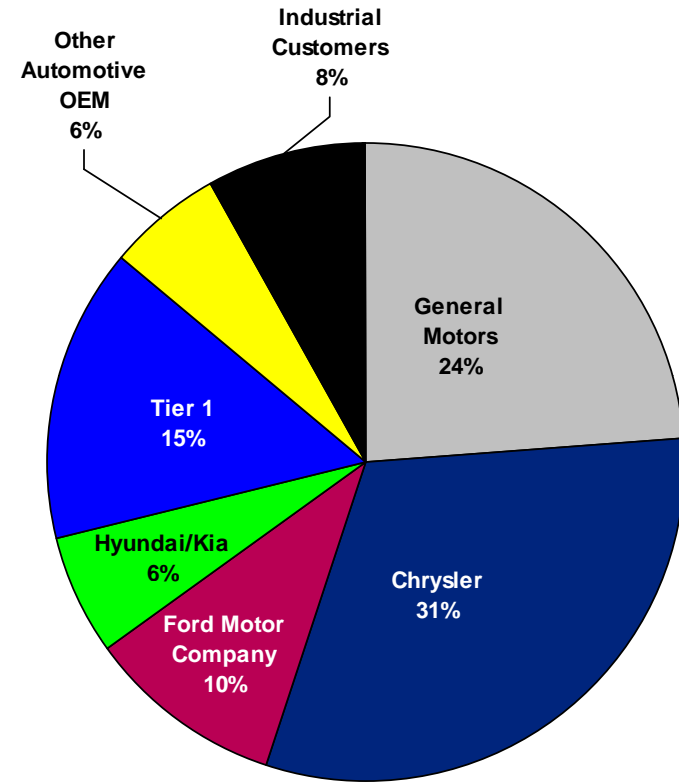

Fiscal Year 2011
Net Sales = \$261 million

Vehicle Platform

Ford Taurus

Ford Taurus X

Ford Expedition

Mercury Sable

Lincoln Navigator

Ford Mustang

**Model Year
Introduction**

2008

2008

2008

2008

2009

2010



- Increased vehicle content
- Good Aftermarket sales potential

- To be used on all Global Epsilon II passenger vehicles worldwide.



- Starting January 2008
- Vehicle platform: DBS and others
- Annual sales volume \$2.5 million
- New technology
 - FOB/IK AIM system
 - Content is Docking Station, Bezel and FOB



Sales (in millions of \$)

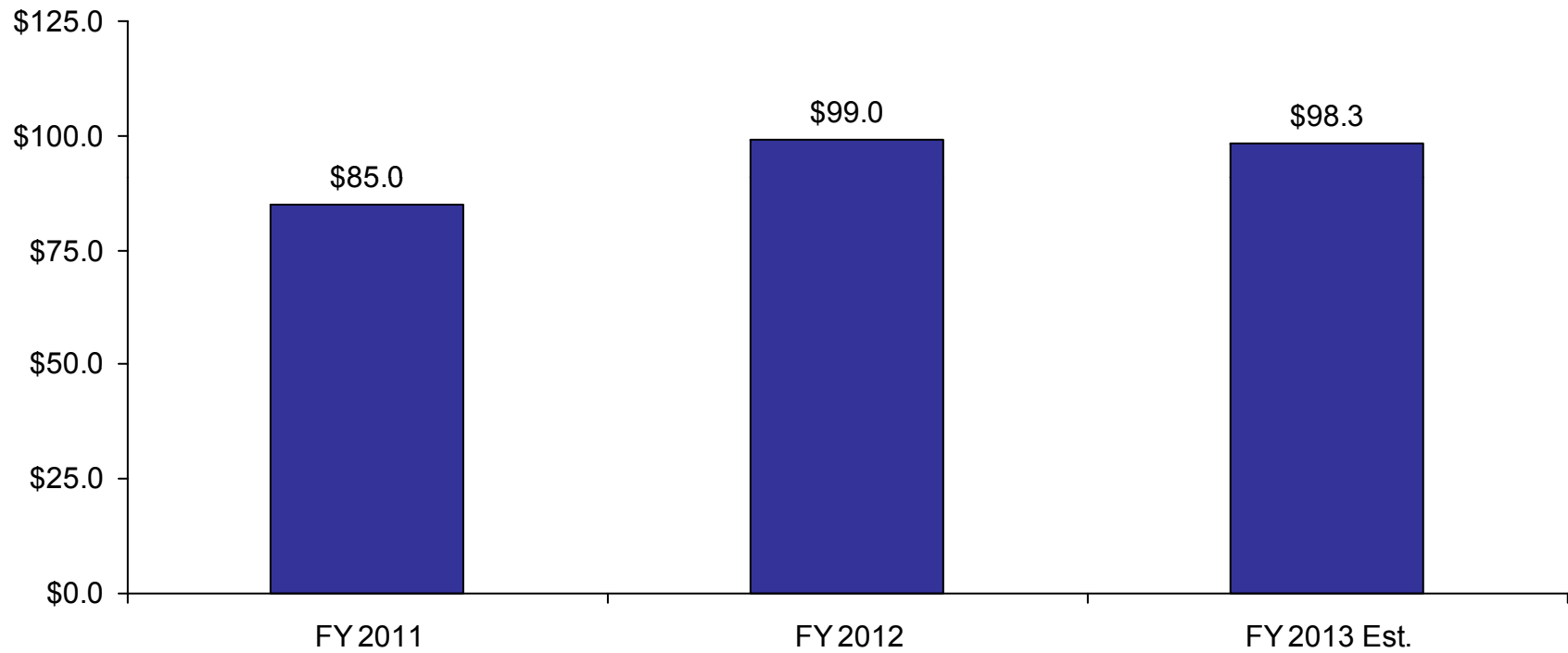

Fiscal Year Ending June



Sales
(in millions of \$)

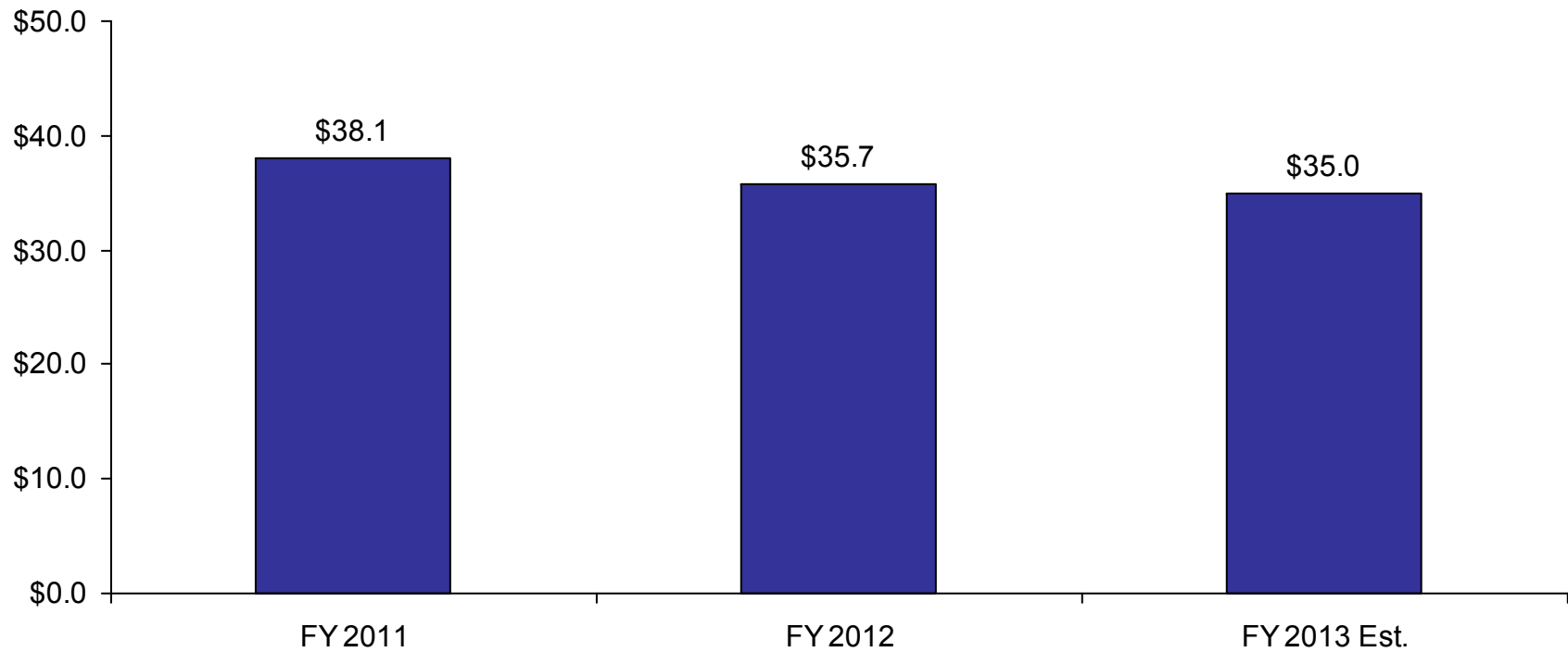

Fiscal Year Ending June

GM Epsilon 2 Ignition Lock Housing Assembly

North American Vehicle Applications

- 2012 Buick LaCrosse
- Buick Regal
- Cadillac SRX
- Chevrolet Cruze
- Chevrolet Equinox
- GMC Terrain
- Opel Ampera
- 2013 Chevrolet Malibu

Volume

2.4 Million pcs/year (including multiple GM global vehicles)

Style

Zinc, column-mounted, versions with and without a solenoid

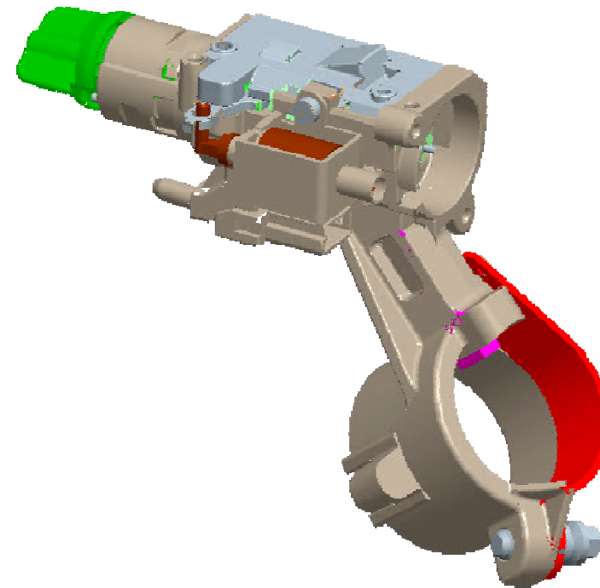

Ford C1 Ignition Lock Housing Assembly

North American Vehicle Applications

- 2012 Ford Focus
- 2013 Ford Escape
- 2014 Lincoln C-CUV

Successful redesign from zinc to plastic (1st of its kind)

Volume

654,000 pcs/year

Style

Plastic, column-mounted



Electronic Steering Column Lock (ESCL)

2013 GM Alpha Platform – Cadillac ATS

- First production ESCL for STRATTEC
- GM Corporate Common Component (sold directly to GM)
- Core design elements to be used in other GM ESCL applications

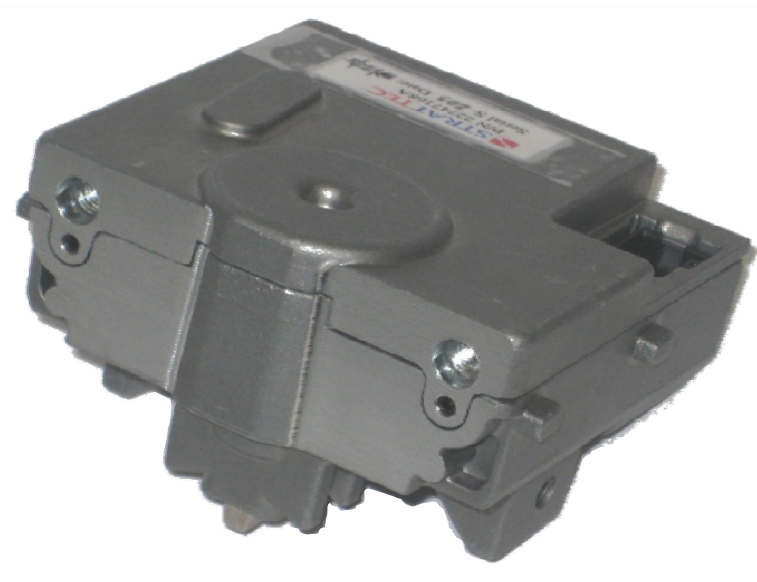

Sales
(in millions of \$)

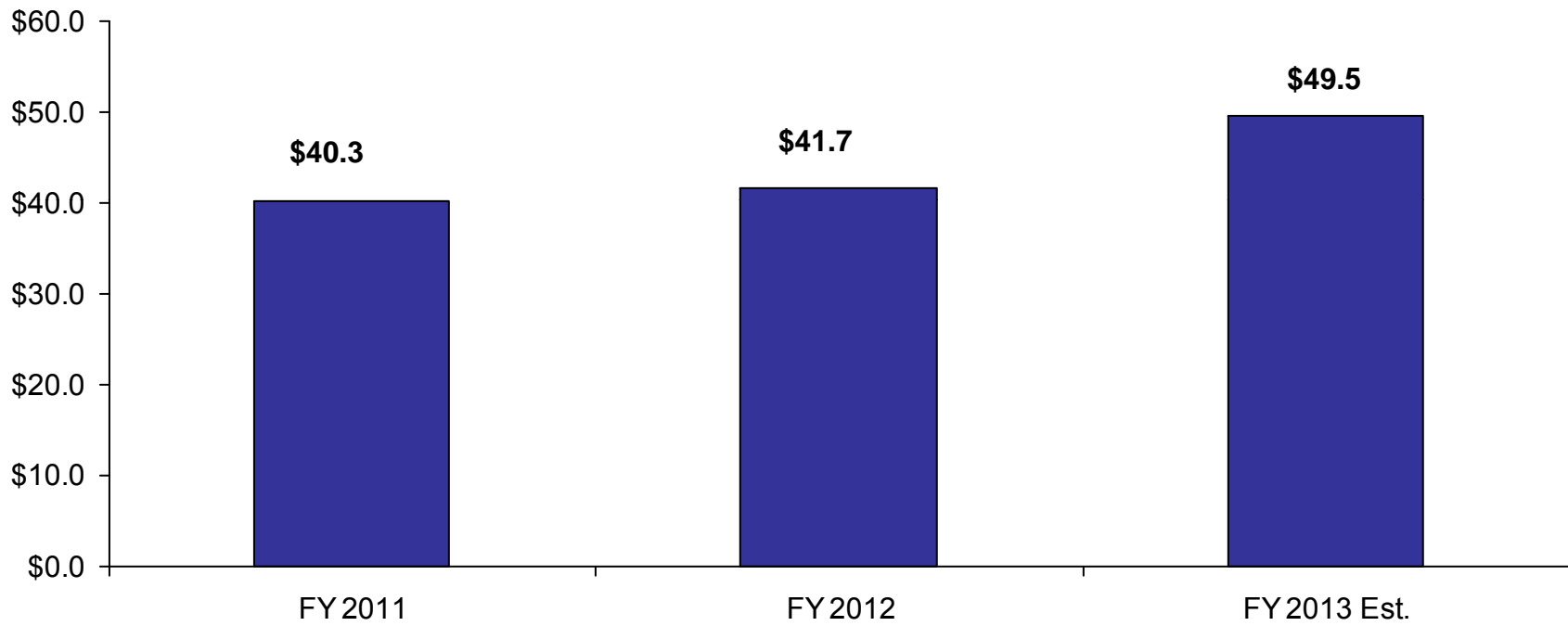

Fiscal Year Ending June

Latches in Production for General Motors



Seat Back Latches



Rear Compartment Latch

2 Versions – power release, or
power release and cinching

Ford Business Mini-Direct Drive Decklid Latch

- Compact Power & Manual Release Latch
- 2013 CD4 Program – Ford Fusion/Lincoln MKZ

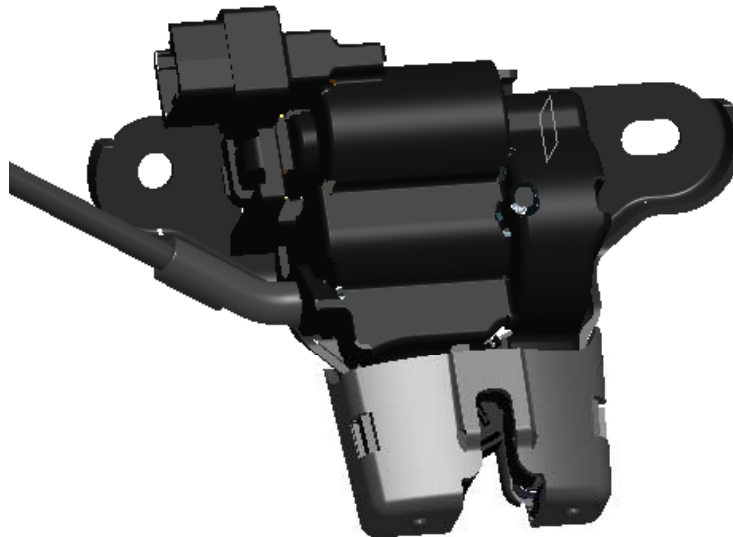

Sales (in millions of \$)

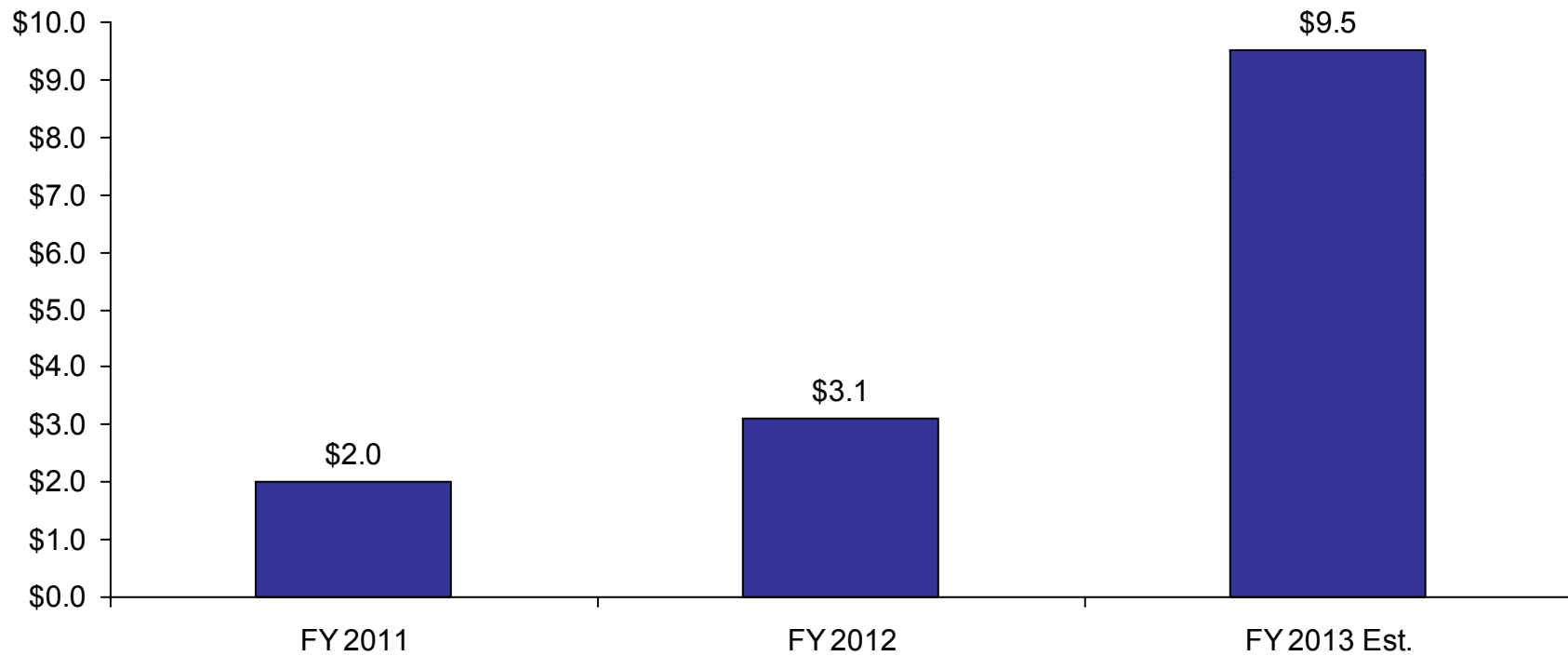

Fiscal Year Ending June



Power Access Business Overview



- **Business Acquired November 2008**
- **Global Customer Base**
- **Power Sliding Door (PSD)**
- **Power Liftgate (PLG)**
- **Power Deck Lid (PDL)**
- **Power Tonneau Cover (PTC)**
- **Power Cinching Latch & Striker**
- **Touchless Obstacle Detection**



VEHICLE ACCESS SYSTEMS TECHNOLOGY



WITTE • STRATTEC • ADAC

Sales (in millions of \$)

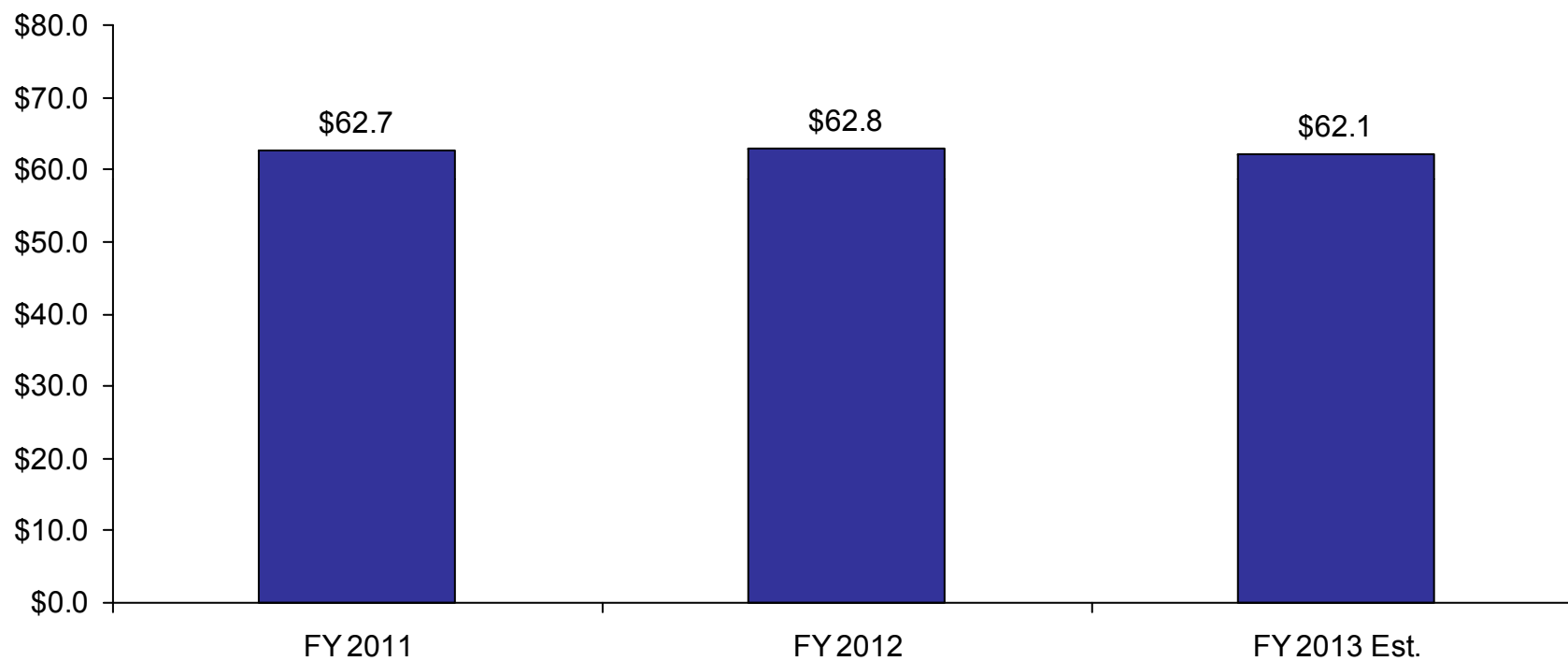

Fiscal Year Ending June



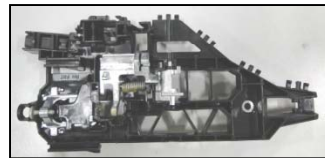
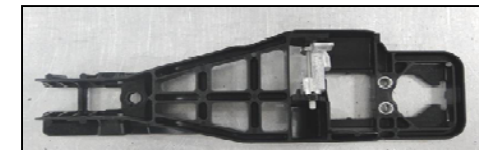
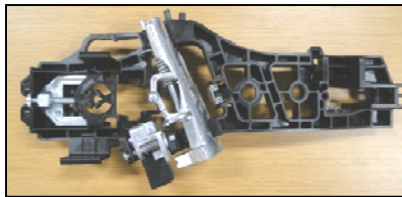
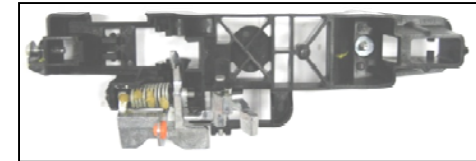
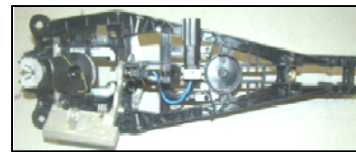
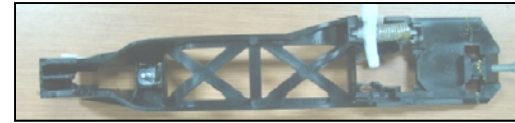

- **Joint Venture with ADAC Automotive. Plastic Injection Molding and Assembly.**
- **Established 2007**
- **Light bar with camera for rear view assist.**
- **Door Chassis and inside handles (with electrical switches and mechanical systems).**

Sales (in millions of \$)

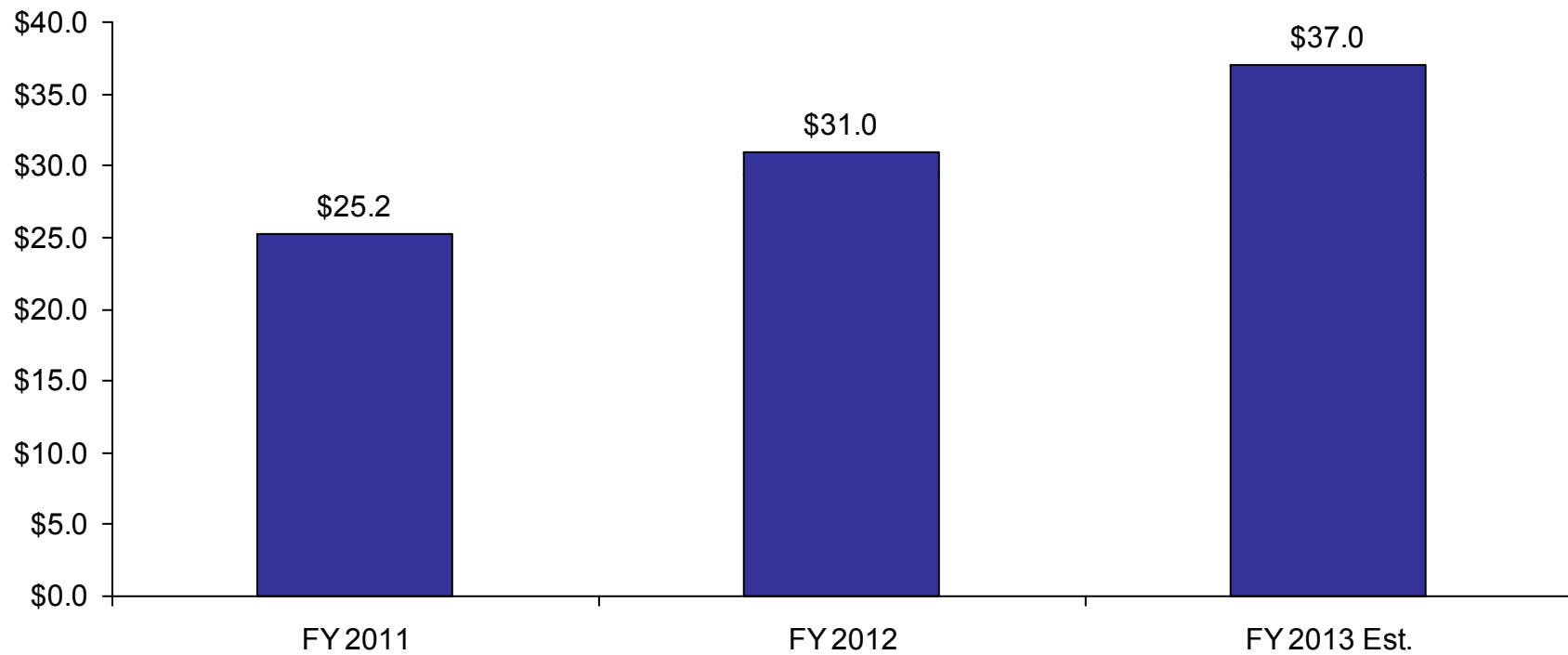

Fiscal Year Ending June



Vehicle Access Systems Technology



VEHICLE ACCESS SYSTEMS TECHNOLOGY



WITTE • STRATTEC • ADAC

- **Strategic partnership:**
 - STRATTEC – Milwaukee, Wisconsin
 - WITTE – Velbert, Germany
 - ADAC – Grand Rapids, Michigan
- **Jointly own:**
 - VAST China – Manufacturing & Engineering
 - VAST Brazil - Manufacturing
 - VAST Japan – Sales
 - VAST Korea – Sales & Engineering
- **Growth opportunity:**
 - India
- **VAST** is the brand we are using to grow our global business and protect our home markets

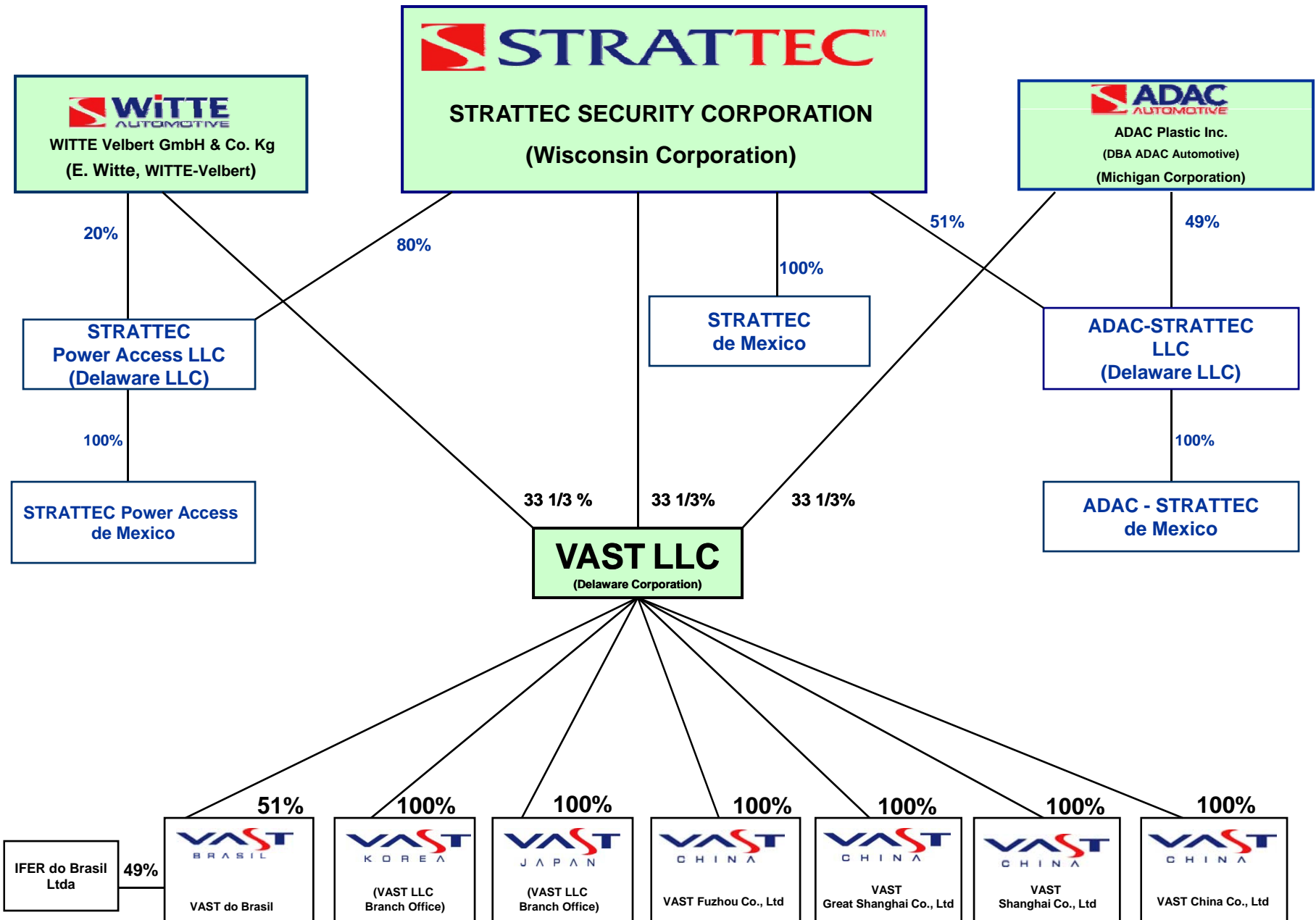

- In excess of \$1 Billion annual sales
- 16 Manufacturing facilities in U.S., Mexico, Germany, Czech Republic, China and Brazil
- 7 Engineering Centers
- Worldwide employment over 7,000

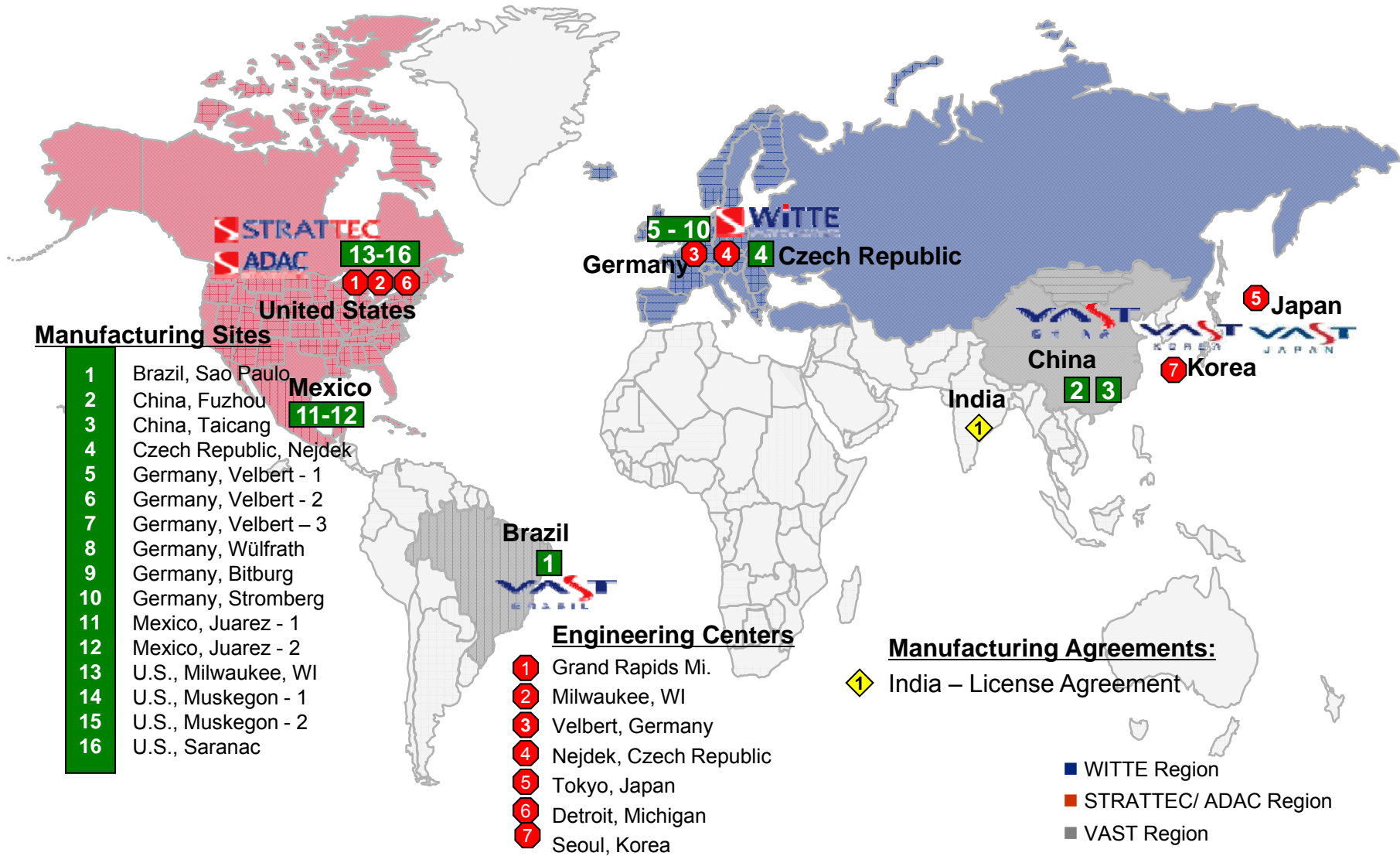



In Millions
Of US Dollars

Sales Growth

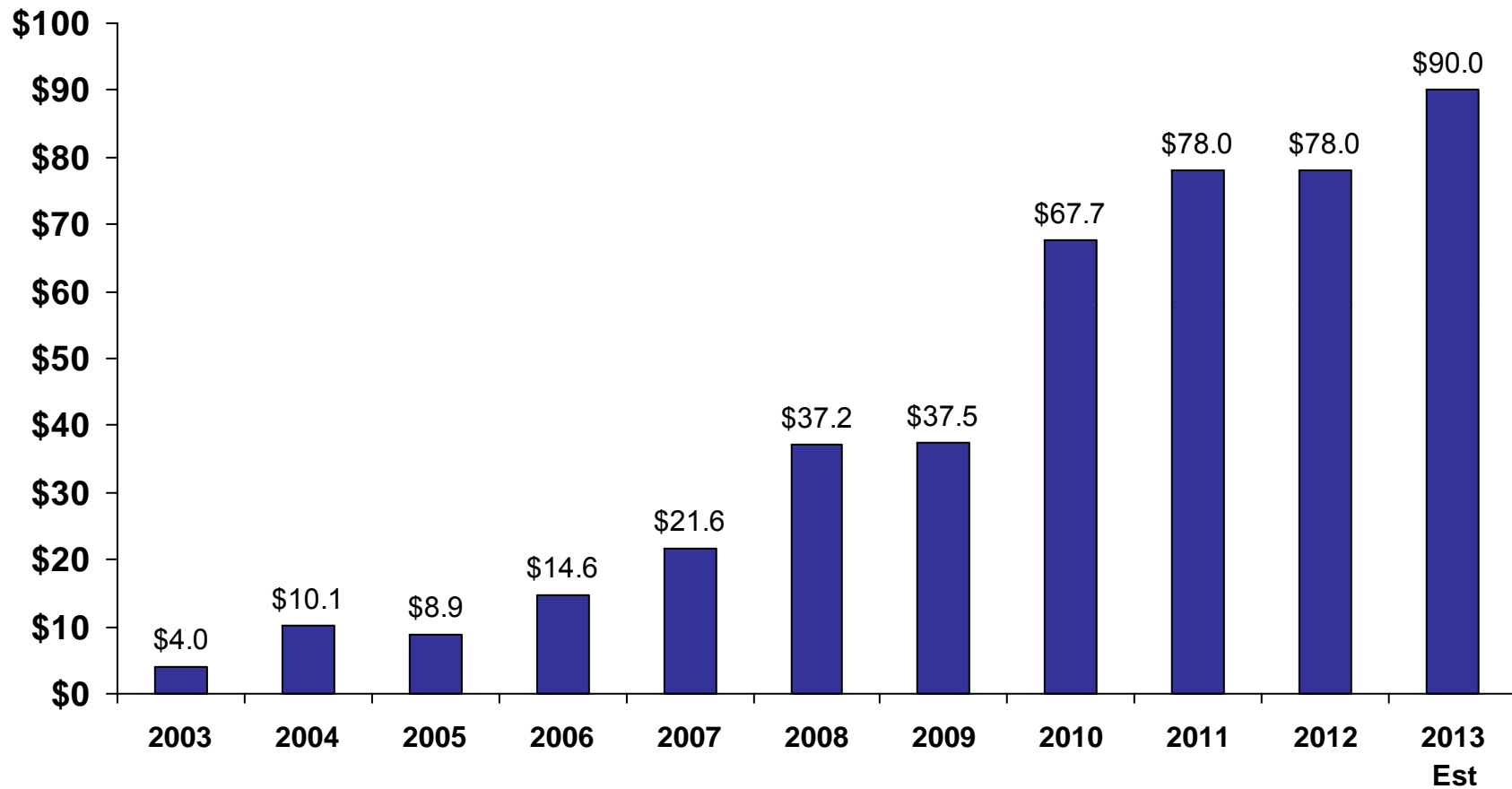

Fiscal Year Ending June

Product Strategy

- Latches (Existing)
- Locks and Keys (Existing)
- Door Handles (New)
- Power Access Products (New)
- Keyless Engine Start Products (New)

**New 150,000 sq. ft. manufacturing facility in Taicang, China.
Operational September 2011.**



- STRATTEC is a very different business than it was 10 years ago
 - Broader product line; less reliance on one product
 - Larger customer base and global footprint
 - Capitalizing on both new product opportunities and utilization of existing assets through STRATTEC Component Solutions to deliver growth
- Focus on key financial performance metrics to:
 - Improve gross profit margins
 - Reduce selling, engineering and administrative costs
 - Maintain strong balance sheet and cash flow for strategic investments

STRATTEC's long-term strategy is focused on maximizing long-term shareholder value by driving profitable growth. Our management believes productivity improvements and cost reductions are critical to our competitiveness, while enhancing the value we deliver to our customers. In order to accomplish this, we have been pursuing, and continue to pursue, the following objectives as summarized below:

- Streamline and standardize processes to increase productivity
- Maintain a disciplined and flexible cost structure to leverage scale and optimize assets utilization and procurement
- Maintain our strong financial position by deploying capital spending targeted for growth and productivity improvement
- Leverage the "VAST Brand" with customer relationships to generate organic growth from global programs
- Offer our customers innovative products and cost savings solutions to meet their changing demands
- Explore and execute targeted mergers and acquisitions with a disciplined due diligence approach and critical financial analysis to drive shareholder value

We use several key performance indicators to gauge progress toward achieving these objectives. These indicators include net sales growth, operating margin improvement, return on capital employed and cash flow from operations.



Questions?